

IN-SIGHT D900 VISION SYSTEM

Solve the most challenging vision applications with AI-based automation

The In-Sight® D900 vision system automates complex applications that are too difficult to deploy with traditional, rule-based machine vision and require reliable, fast, and consistent results not possible with human inspection. Embedded with a full suite of both edge learning and deep learning tools, In-Sight D900 solves a range of tasks from defect detection to assembly verification and optical character recognition (OCR). Processing takes place on-device, which eliminates the need for a PC, simplifying application deployment and bringing the power of AI to non-programmers.



Read challenging characters and text in minutes

The In-Sight D900 deciphers badly deformed, skewed, and poorly etched codes using optical character recognition. Equipped with a pre-trained font library, the read tool works right out of the box, drastically reducing development time. Simply define the region of interest and set the character size. In situations where new characters are introduced, the tool can be easily retrained to read application-specific characters.

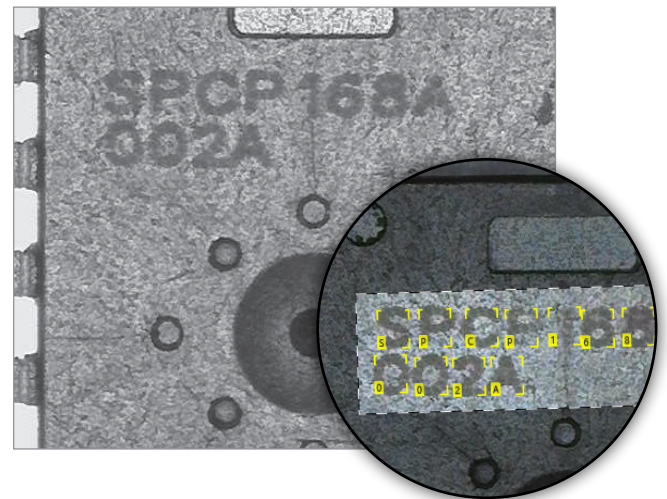
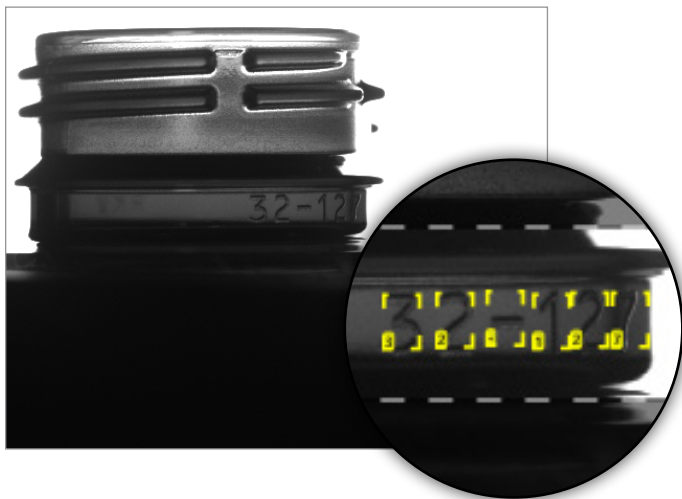

Perform fast and accurate assembly verification

In-Sight D900 reliably detects complex features and objects and verifies parts and kits are assembled correctly based on their location within a user-defined layout. The check tool can be trained to recognize an extensive number, and variety, of components, which can be located in the image even if they appear at different angles or vary in size.

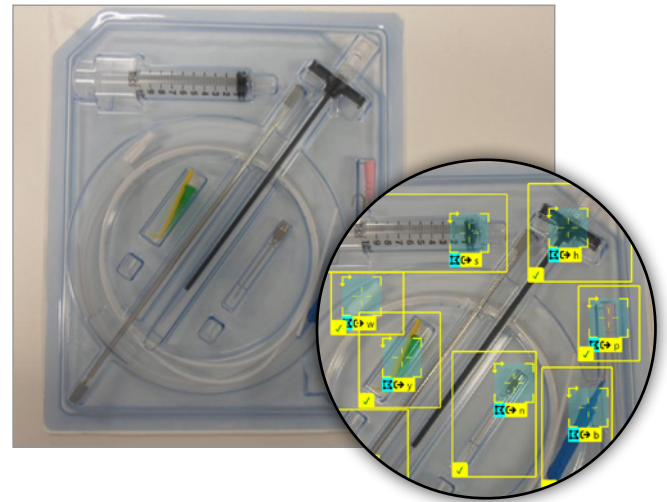
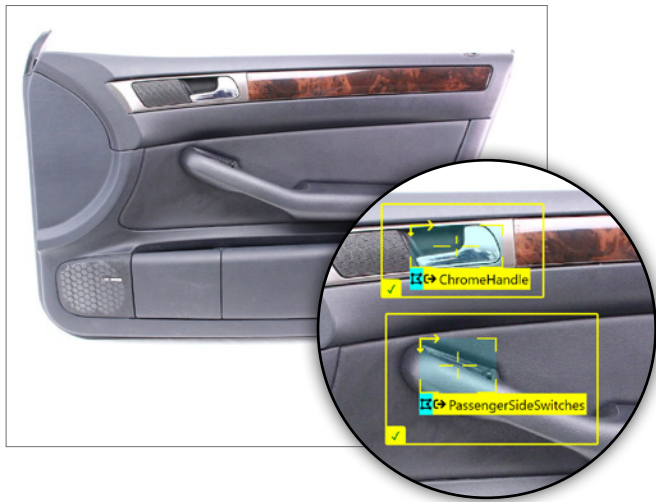

Detect and analyze subtle defects

The detect tool embedded within the In-Sight D900 is ideal for finding anomalies on complex parts and surfaces, even in situations where defects can be unpredictable in their appearance.

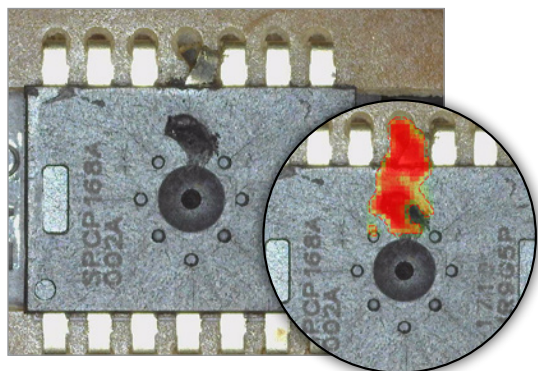
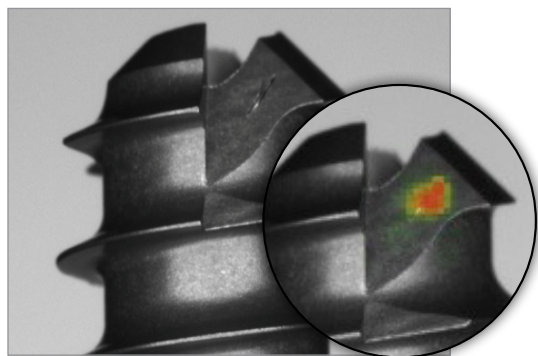

Precisely classify any defect

The classify tool leverages AI to automatically identify and sort objects into classes. Within the same class of objects, it distinguishes between visually similar, but different defects to determine if they represent a true defect or an acceptable variation.

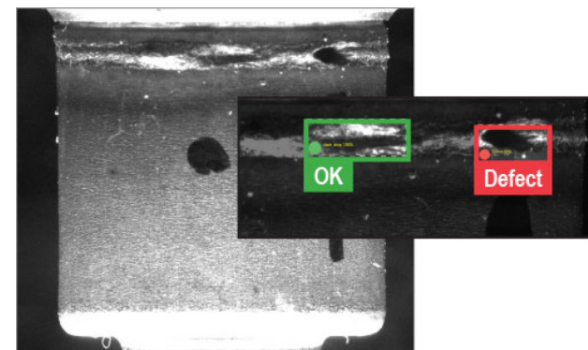
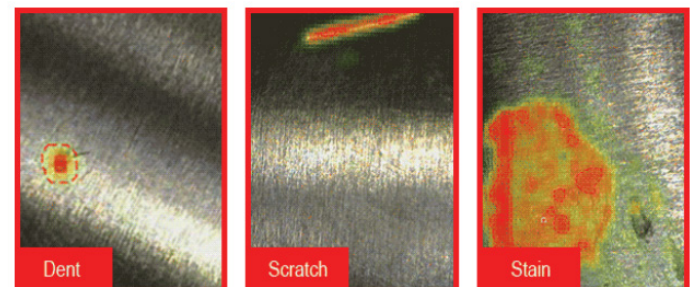

Quickly setup and deploy applications

With an intuitive interface and a full communications function set, In-Sight spreadsheet simplifies application development and streamlines factory integration. It also allows you to combine rules-based and AI tools in the same job, delivering faster deployments.

Address your current and future needs with hardware modularity

Highly flexible in design, the In-Sight D900 vision system includes field-changeable lighting, lenses, filters, and covers that can be customized to match your exact application requirements. It also includes an embedded inference engine that solves complex tasks at production line speeds.



The power of AI for everyone

The In-Sight D900 is embedded with powerful edge learning tools that leverage AI technology to learn “on the edge,” in real time, delivering fast, accurate results. The tools are simple to setup, requiring smaller image sets and shorter validation periods than traditional deep learning. They can be trained in minutes using as few as five to ten images per class with no coding required. This makes them an accessible automation solution for a range of users and skill levels.

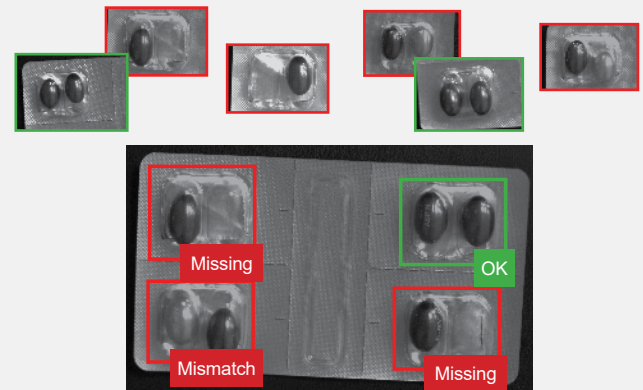

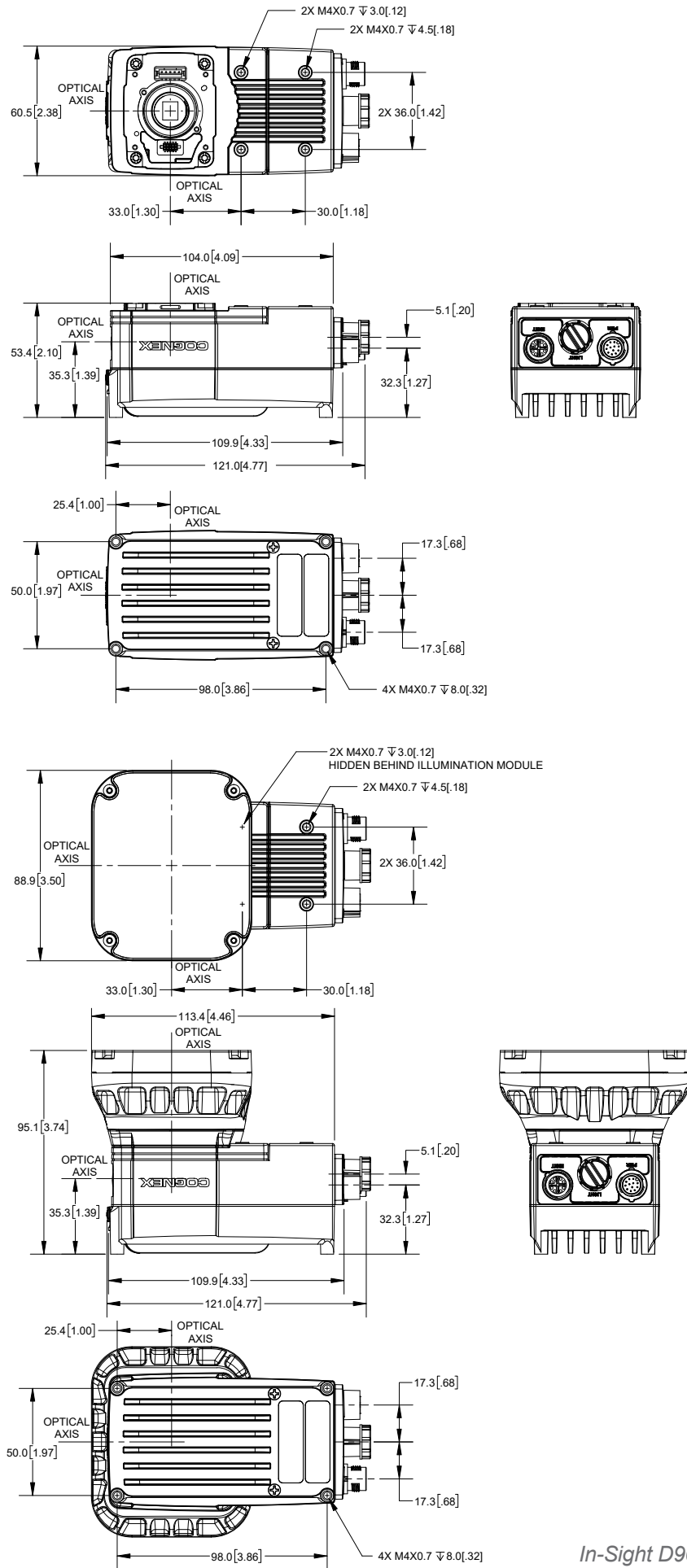

IN-SIGHT D900 SPECIFICATIONS

		D905M	D905C	D902M	D902C
Image Type		Monochrome	Color	Monochrome	Color
Imager Type		2/3 inch CMOS (3.45 μ m x 3.45 μ m pixels)		1/2.3 inch CMOS (3.45 μ m x 3.45 μ m pixels)	
Resolution (pixels)		5 MP (2448 x 2048)		2.3 MP (1920 x 1200)	
Acquisition Speed (Max)		26 fps	16 fps	51 fps	34 fps
Memory	File storage	16 GB non-volatile flash memory; unlimited storage via remote network device			
	Processing	3 GB SDRAM			
	Additional Storage	8 GB micro SD card, network drive via FTP over gigabit network			
Optics	Lenses	C-Mount, S-Mount, Autofocus			
	Indicator LEDs	SD card status, pass/fail LED and 360° viewing indicator ring, network LED, and error LED			
	Lighting	External lights via light control connector			
I/O	Network	Gigabit Ethernet (10/100/1000 Mbps)			
	Built-in	1 dedicated trigger IN, 1 general purpose IN, 2 general purpose OUT, 2 bi-direction IN/OUT			
Mechanical	Industrial M12 Connectors	Power/I/O; Ethernet; External light power/control			
	Dimensions	53.4 mm (2.10 in) x 60.5 mm (2.38 in) x 121.0 mm (4.77 in)			
	Weight	380 g (13.4 oz.)			
	Protection	IP67 with C-mount lens cover or integrated light connected			
Power		24 VDC			

COGNEX

Companies around the world rely on Cognex vision and barcode reading solutions to optimize quality, drive down costs and control traceability.

Corporate Headquarters One Vision Drive Natick, MA 01760 USA

Regional Sales Offices

Americas

North America +1 844 999 2469
Brazil +55 11 4210 3919
Mexico +800 733 4116

Europe

Austria +43 800 28 16 32
Belgium +32 289 370 75
Czechia +420 800 023 519
France +33 1 76 54 93 18
Germany +49 721 958 8052
Hungary +36 800 80291

Ireland +353 21 421 7500
Italy +39 02 3057 8196
Netherlands +31 207 941 398
Poland +48 717 121 086
Romania +40 741 041 272
Spain +34 93 299 28 14
Sweden +46 21 14 55 88
Switzerland +41 445 788 877
Turkey +90 216 900 1696
United Kingdom +44 121 29 65 163

Asia-Pacific

Australia +61 2 7202 6910
China +86 21 5875 1133

India +91 7305 040397
Indonesia +62 21 3076 1792
Japan +81 3 5977 5400
Korea +82 2 539 9047
Malaysia +6019 916 5532
New Zealand +64 9 802 0555
Philippines +63 2 8539 3990
Singapore +65 3158 3322
Taiwan +886 02 7703 2848
Thailand +66 6 3230 9998
Vietnam +84 98 2405167

© Copyright 2023, Cognex Corporation. All information in this document is subject to change without notice. All Rights Reserved. Cognex and In-Sight are registered trademarks of Cognex Corporation. ViDi and PatMax RedLine are trademarks of Cognex Corporation. All other trademarks are property of their respective owners. Lit. No. ISD900-DS-09-2023

www.cognex.com